

ΘΕΟΧΑΡΙΔΗΣ Α.Ε.Β.Ε.
ΓΕΩΡΓΙΚΑ ΜΗΧΑΝΗΜΑΤΑ & ΕΞΑΡΤΗΜΑΤΑ



ΑΝΤΑΛΛΑΚΤΙΚΑ SPARE PARTS FOR

ΣΠΑΡΤΙΚΗΣ/SEEDING MACHINE
ΔΙΣΚΟΣΒΑΡΝΑΣ/DISC HARROW
ΑΡΟΤΡΟΥ/PLOUGH
ΕΝΣΙΡΩΣΗΣ/HARVESTER
ΦΡΕΖΑΣ/TILLER
ΚΑΤΑΣΤΡΟΦΕΑ/FLAIL MOWER
ΚΑΛΛΙΕΡΓΗΤΗ/CULTIVATOR
ΧΟΡΤΟΚΟΠΤΙΚΟΥ/DISC MOWER



Catalogue **C**^[B]
2024 | ΙΟΥΝΙΟΣ

ΔΙΣΚΟΣΒΑΡΝΑΣ/DISC HARROW

ΔΙΣΚΟΙ ΔΙΣΚΟΣΒΑΡΝΑΣ **ΙΣΙΟΙ** /03

ΔΙΣΚΟΙ ΔΙΣΚΟΣΒΑΡΝΑΣ **ΟΔΟΝΤΩΤΟΙ** /03

ΣΠΑΡΤΙΚΗΣ/SEEDING MACHINE

ΔΙΣΚΟΙ ΣΠΑΡΤΙΚΗΣ **ΙΣΙΟΙ** /04

ΝΥΧΙ ΣΠΑΡΤΙΚΗΣ /04

ΑΡΟΤΡΟΥ/PLOUGH

ΤΥΠΟΥ NARDI /04

ΤΥΠΟΥ ΟΤΜΑ /04

ΤΥΠΟΥ ΚVERNELAND /05

ΤΥΠΟΥ VOGEL NOOT /05

ΤΥΠΟΥ GRÉGOIRE BESSON /05

ΕΝΣΙΡΩΣΗΣ/HARVESTER

ΔΙΣΚΟΙ ΕΝΣΙΡΩΤΙΚΟΥ /06

ΜΑΧΑΙΡΙΑ ΕΝΣΙΡΩΤΙΚΟΥ /06

ΦΡΕΖΑΣ/TILLER

ΜΑΧΑΙΡΙΑ ΦΡΕΖΑΣ /07-08

ΜΑΧΑΙΡΙΑ ΦΡΕΖΟΣΚΑΛΙΣΤΗΡΙΟΥ /08-09

ΜΑΧΑΙΡΙΑ ΣΚΑΠΤΙΚΩΝ /09-10

ΣΒΟΛΟΚΟΠΤΗ/ROTARY HARROW

ΜΑΧΑΙΡΙΑ ΣΒΟΛΟΚΟΠΤΗ /11

ΣΤΕΛΕΧΟΚΟΠΤΗ/FINISHING MOWER

ΜΑΧΑΙΡΙΑ ΣΤΕΛΕΧΟΚΟΠΤΗ /11

ΚΑΤΑΣΤΡΟΦΕΑ/FLAIL MOWER

ΜΑΧΑΙΡΙΑ ΚΑΤΑΣΤΡΟΦΕΑ /12

ΣΦΥΡΙΑ ΚΑΤΑΣΤΡΟΦΕΑ /13-14

ΚΑΛΛΙΕΡΓΗΤΗ/CULTIVATOR

RIPPER ΚΑΛΛΙΕΡΓΗΤΗ **ΚΑΡΔΙΕΣ** /15

RIPPER ΚΑΛΛΙΕΡΓΗΤΗ **ΧΕΛΙΔΟΝΕΣ** /15

FLEX ΚΑΛΛΙΕΡΓΗΤΗ **ΚΑΡΔΙΕΣ** /16

FLEX ΚΑΛΛΙΕΡΓΗΤΗ **ΝΥΧΙΑ** /16

FLEX ΚΑΛΛΙΕΡΓΗΤΗ **ΣΥΝΔΕΤΗΡΕΣ** /17

FLEX ΚΑΛΛΙΕΡΓΗΤΗ **ΕΛΑΣΜΑΤΑ** /17

ΣΠΕΙΡΩΤΟΥ ΚΑΛΛΙΕΡΓΗΤΗ **ΝΥΧΙΑ** /18

CHISEL ΚΑΛΛΙΕΡΓΗΤΗ **ΝΥΧΙΑ** /18

RIPUNTATORE ΥΠΕΔΑΦΙΟΚΑΛΛΙΕΡΓΗΤΗ **ΝΥΧΙΑ** /19

ΣΚΑΛΙΣΤΗΡΙΟΥ/ROW CROP CULTIVATOR

ΠΤΕΡΥΓΙΑ ΣΚΑΛΙΣΤΗΡΙΟΥ /20

ΧΕΛΙΔΟΝΕΣ ΣΚΑΛΙΣΤΗΡΙΟΥ /20

ΑΥΛΑΚΩΤΗΡΑΣ ΣΚΑΛΙΣΤΗΡΙΟΥ /20

HORSCH ΚΑΛΛΙΕΡΓΗΤΗ **ΠΤΕΡΥΓΙΑ** /21

ΧΟΡΤΟΚΟΠΤΙΚΟΥ/DISC MOWER

ΛΕΠΙΔΕΣ ΧΟΡΤΟΚΟΠΤΙΚΟΥ /22

ΙΣΙΟΣ ΔΙΣΚΟΣ

Plain harrow disc



ΚΩΔ. /Code:	ΔΙΑΜΕΤΡΟΣ ΕΞΩΤΕΡΙΚΗ /External diameter (Ø) mm	ΤΡΥΠΑ /Hole Ø mm	ΠΑΧΟΣ /Thickness mm	€
00011425	460	26	4	16,50
00017006	460	30	4	16,50
00011703	510	26		18,50
00011704	510	30		17,00
00017008	560	31		27,00
00018565	560	36	4,5	28,50

ΟΔΟΝΤΩΤΟΣ ΔΙΣΚΟΣ

Notched harrow disc

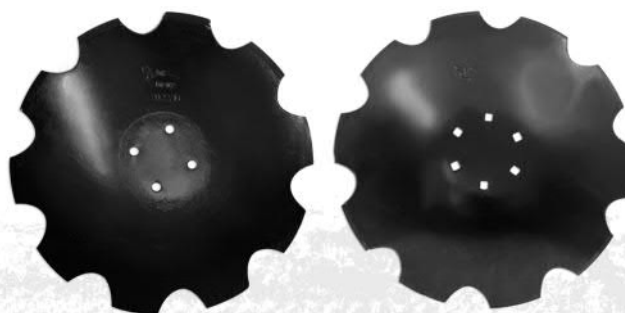

ΚΩΔ. /Code:	ΔΙΑΜΕΤΡΟΣ ΕΞΩΤΕΡΙΚΗ /External diameter (Ø) mm	ΤΡΥΠΑ /Hole Ø mm	ΠΑΧΟΣ /Thickness mm	€
00011702	460	26		16,50
00017007	460	30		16,50
00011705	510	26		17,00
00011706	510	30		17,00
00017009	560	31		25,00
00018570	560	36	4,5	28,50

ΟΔΟΝΤΩΤΟΣ ΔΙΣΚΟΣΓΙΑ ΜΕΤΑΛΛΙΚΟ ΚΟΥΖΙΝΕΤΟ
(4/6 ΤΡΥΠΕΣ)Notched harrow disc
for metallic bearing
(4/6 Holes)

ΚΩΔ. /Code:	ΔΙΑΜΕΤΡΟΣ ΕΞΩΤ. /Ext.diameter (Ø) mm	ΤΡΥΠΕΣ /Holes (Ø) mm	ΑΠΟΣΤΑΣΗ ΤΡΥΠΑ-ΤΡΥΠΑ (o-o distance) mm	ΠΑΧΟΣ /Thickness mm	€
00018550	510	4x12,5	98 / 70	4,5	27,00
00018555	560	4x12,5	98 / 70	4,5	34,00
00018560	610	4x12,5	98 / 70	5	34,00
00017844	560	6x	122 / 62	5	37,50

ΙΣΙΟΣ ΔΙΣΚΟΣ

Plain seeding disc

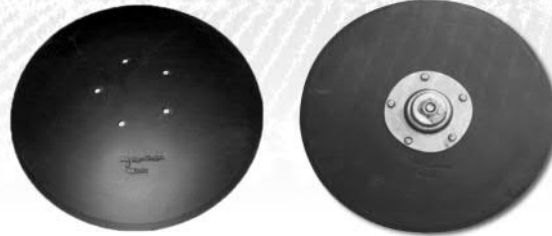

ΚΩΔ. /Code:	ΠΡΟΣΑΡΜΟΓΗ Fitting	ΔΙΑΜΕΤΡΟΣ ΕΞΩΤΕΡΙΚΗ /External diameter (Ø) mm	ΤΡΥΠΑ /Hole Ø mm	ΠΑΧΟΣ /Thickness mm	€
00011427	ΖΗΤΑ	332	5	3	9,30
00011424	ΒΕΚΑΜ	332	5	4,5	9,30
10002352	ΖΗΤΑ (ΚΟΜΠΛΕ)	332	5	3	13,64
10002351	ΒΕΚΑΜ (ΚΟΜΠΛΕ)	332	5	4,5	13,23

ΝΥΧΙ ΣΠΑΡΤΙΚΗΣ/BALESTRA

Molded reversible soc
BALESTRA



ΚΩΔ. /Code:	ΜΗΚΟΣ /Length mm	ΠΛΑΤΟΣ /Width mm	ΤΡΥΠΕΣ /Holes Ø mm	(ΤΡΥΠΑ-ΤΡΥΠΑ) /Hole-Hole distance mm	ΠΑΧΟΣ /Thickness mm	€
00013354	230	47	(2) 10x10	50	7	1,66

AGROZAPPA / ΑΝΤΑΛΛΑΚΤΙΚΑ ΑΡΟΤΡΩΝ

NARDI

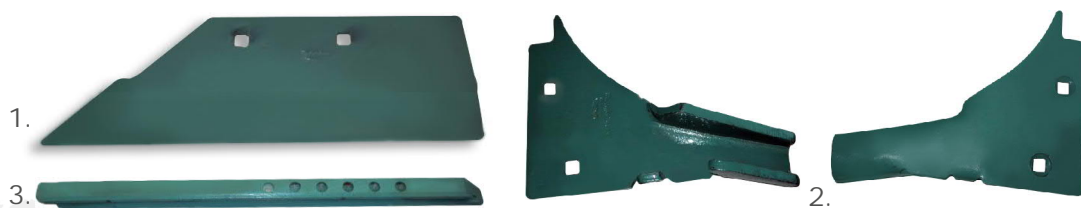

ΚΩΔ. /Code:	ΠΕΡΙΓΡΑΦΗ /Description	ΟΕΜ /Code	(ΤΡΥΠΑ-ΤΡΥΠΑ) /Hole-Hole	€
00008878	NARDI 1.ΥΝΙ ΔΕΞΙΟ	6C54DX	115mm	21,98
00010262	NARDI 2.ΒΑΣΗ ΛΟΣΤΑΡΙΟΥ ΔΕΞΙΑ	5C-7C 83DX		28,57
00010263	NARDI 3.ΛΟΣΤΑΡΙ ΔΕΞΙΟ 30x32			29,31

ΟΤΜΑ

ΚΩΔ. /Code:	ΠΕΡΙΓΡΑΦΗ Description	€
10002112	ΟΤΜΑ ΛΟΣΤΑΡΙ 35x35	27,00

KVERNELAND



ΚΩΔ. /Code:	ΠΕΡΙΓΡΑΦΗ /Description	ΟΕΜ /Code	ΤΡΥΠΑ-ΤΡΥΠΑ /Hole-Hole	€
00011430	KVR 1.ΠΡΟΫΝΙ ΔΕΞΙΟ 12mm	53090	40mm	4,00
00011636	KVR 2.ΠΡΟΫΝΙ ΑΡΙΣΤΕΡΟ 12mm	63090	40mm	4,80
00011400	KVR 3.ΥΝΙ 16" ΔΕΞΙΟ 390mm (ΑΝΩ ΠΛΕΥΡΑ)	73004	Δ120/Α110mm	22,50
00014292	KVR ΥΝΙ 16" ΑΡΙΣΤΕΡΟ 390mm (ΑΝΩ ΠΛΕΥΡΑ)	73005	Δ120/Α110mm	24,00
00016709	KVR 5.ΥΝΙ 16" ΔΕΞΙΟ Νο 1-5	63015		32,90
00014293	KVR 4.ΥΝΙ 18" ΔΕΞΙΟ	73006	Δ120/Α110mm	24,50
00014294	KVR ΥΝΙ 18" ΑΡΙΣΤΕΡΟ	73007	Δ120/Α110mm	28,00
00015521	KVR 6.ΥΝΙ 18" ΔΕΞΙΟ (ΝΕΟΥ ΤΥΠΟΥ)	73080		30,00



VOGEL NOOT



ΚΩΔ. /Code:	ΠΕΡΙΓΡΑΦΗ /Description	ΟΕΜ /Code	ΤΡΥΠΑ-ΤΡΥΠΑ /Hole-Hole	€
00018812	VN 1.ΠΡΟΫΝΙ ΔΕΞΙΟ 290x65x14mm	WU801101	50mm	5,00
00018813	VN 2.ΠΡΟΫΝΙ ΑΡΙΣΤΕΡΟ 290x65x14mm	WU801102	50mm	5,00

GRÉGOIRE BESSON

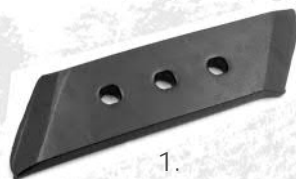

ΚΩΔ. /Code:	ΠΕΡΙΓΡΑΦΗ /Description	ΟΕΜ /Code	ΤΡΥΠΑ-ΤΡΥΠΑ /Hole-Hole	€
00014290	GB 1.ΠΡΟΫΝΙ ΔΕΞΙΟ (3ΤΡ.) 305x75x15mm	173332	58mm	7,50

ΔΙΣΚΟΙ ΕΝΣΙΡΩΤΙΚΟΥ

Forage harvester disc



ΔΙΣΚΟΣ ΕΝΣΙΡΩΤΙΚΟΥ
LUCLAR (ΔΕΞΙΟΣΤΡΟΦΟΣ)

ΔΙΑΜΕΤΡΟΣ/Diameter Ø: 95mm

ΠΑΧΟΣ/Thickness: 5mm

ΤΡΥΠΑ/Hole Ø: 10,5mm

00012678

ΚΩΔ./Code

3,22 €



ΔΙΣΚΟΣ ΕΝΣΙΡΩΤΙΚΟΥ
(ΧΩΡΙΣ ΔΟΝΤΙΑ)

ΔΙΑΜΕΤΡΟΣ/Diameter Ø: 95mm

ΠΑΧΟΣ/Thickness: 5mm

ΤΡΥΠΑ/Hole Ø: 11mm

00011967

ΚΩΔ./Code

2,50 €



ΔΙΣΚΟΣ ΕΝΣΙΡΩΤΙΚΟΥ
SEKO

ΔΙΑΜΕΤΡΟΣ/Diameter Ø: 95mm

ΠΑΧΟΣ/Thickness: 5mm

ΤΡΥΠΑ/Hole Ø: 10,5mm

00019438

ΚΩΔ./Code

2,90 €

ΜΑΧΑΙΡΙΑ ΕΝΣΙΡΩΤΙΚΟΥ

Forage harvester disc



(UNIVERSAL)
ΜΑΧΑΙΡΙ ΕΝΣΙΡΩΤΙΚΟΥ
ΚΑΘΕΤΟΥ ΑΞΟΝΑ

ΜΗΚΟΣ/Length: 428mm

ΠΑΧΟΣ/Thickness: 5mm

ΤΡΥΠΕΣ/Holes Ø: (3) 19mm

(ΤΡΥΠΑ-ΤΡΥΠΑ)

/Hole - Hole distance: 80mm

00018816

ΚΩΔ./Code

27,00 €



ΜΑΧΑΙΡΙ ΕΝΣΙΡΩΤΙΚΟΥ
ΔΙΠΛΗΣ ΚΟΠΗΣ STORTI

ΜΗΚΟΣ/Length: 240mm

ΠΛΑΤΟΣ/Width: 137mm

ΠΑΧΟΣ/Thickness: 8mm

ΤΡΥΠΕΣ/Holes Ø: (3) 16mm

(ΤΡΥΠΑ-ΤΡΥΠΑ)

/Hole - Hole distance: 55mm

00018803

ΚΩΔ./Code

10,00 €



ΜΑΧΑΙΡΙ ΕΝΣΙΡΩΤΙΚΟΥ
LUCLAR COMAG

ΜΗΚΟΣ/Length: 195mm

ΠΛΑΤΟΣ/Width: 95mm

ΤΡΥΠΑ/Hole Ø: 24x13mm

(ΤΡΥΠΑ-ΤΡΥΠΑ)

/Hole - Hole distance: 80mm

▶ **ΑΡΙΣΤΕΡΟ**/Left:

00018815

ΚΩΔ./Code

7,00 €

▶ **ΔΕΞΙ**/Right:

00018814

ΚΩΔ./Code

7,00 €



(UNIVERSAL)
ΜΑΧΑΙΡΙ ΕΝΣΙΡΩΤΙΚΟΥ
ΚΑΘΕΤΟΥ ΑΞΟΝΑ

ΜΗΚΟΣ/Length: 560mm

ΠΑΧΟΣ/Thickness: 5mm

ΤΡΥΠΑ Α/Hole Ø: 12mm

ΤΡΥΠΑ Β/Hole Ø: 20mm

00018817

ΚΩΔ./Code

35,00 €



ΜΑΧΑΙΡΙ ΕΝΣΙΡΩΤΙΚΟΥ
ΔΙΠΛΗΣ ΚΟΠΗΣ STORTI

ΟΕΜ: 22311

ΜΗΚΟΣ/Length: 160mm

ΠΛΑΤΟΣ/Width: 85mm

ΠΑΧΟΣ/Thickness: 6mm

ΤΡΥΠΕΣ/Holes: 2

(ΤΡΥΠΑ-ΤΡΥΠΑ)

/Hole - Hole distance: 95mm

00019439

ΚΩΔ./Code

5,50 €



ΜΑΧΑΙΡΙ ΕΝΣΙΡΩΤΙΚΟΥ
STORTI

ΟΕΜ: 22650

ΜΗΚΟΣ/Length: 195mm

ΠΛΑΤΟΣ/Width: 53mm

ΠΑΧΟΣ/Thickness: 5mm

ΤΡΥΠΕΣ/Holes: 2

(ΤΡΥΠΑ-ΤΡΥΠΑ)

/Hole - Hole distance: 115mm

00019440

ΚΩΔ./Code

3,90 €

ΜΑΧΑΙΡΙΑ ΦΡΕΖΑΣ MASCHIO

Blades for MASCHIO tillers



ΓΩΝΙΑ

MASCHIO B/BI/C/SC

ΠΡΟΣΑΡΜΟΓΗ/Fitting:
MASCHIO B/BI/C/SC
OEM: 01110428 / 01110429

A: 215mm B: 140mm C: 25mm

ΛΑΜΑ/Plate: 80x8mm

ΤΡΥΠΕΣ/Holes Ø: (2) 14,5mm

(ΤΡΥΠΑ-ΤΡΥΠΑ)

/Hole - Hole distance: 56mm

00010739*

ΚΩΔ./Code

3,93 €

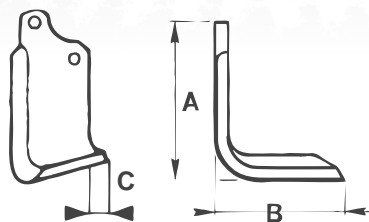

MASCHIO W

ΠΡΟΣΑΡΜΟΓΗ/Fitting:
MASCHIO W
OEM: 48000404 / 48000405

A: 180mm B: 115mm C: mm

ΛΑΜΑ/Plate: 60x6mm

ΤΡΥΠΕΣ/Holes Ø: (2) 12,5mm

(ΤΡΥΠΑ-ΤΡΥΠΑ)

/Hole - Hole distance: 44mm

00015833

ΚΩΔ./Code

3,30 €



ΓΩΝΙΑ (Blue)

MASCHIO B/BI/C/SC

ΠΡΟΣΑΡΜΟΓΗ/Fitting:
MASCHIO B/BI/C/SC
OEM: M01110428/M01110429

A: 215mm B: 140mm C: 25mm

ΛΑΜΑ/Plate: 80x8mm

ΤΡΥΠΕΣ/Holes Ø: (2) 14,5mm

(ΤΡΥΠΑ-ΤΡΥΠΑ)

/Hole - Hole distance: 56mm

► Σημείωση: **Advanced Blue Power**

00016676*

ΚΩΔ./Code

3,93 €

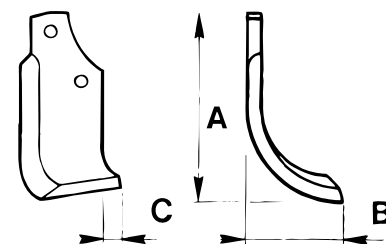

MASCHIO

A/E/H/AS/AZ

ΠΡΟΣΑΡΜΟΓΗ/Fitting:
MASCHIO A/E/H/AS/AZ
OEM: M19100423 / M19100424

A: 190mm B: 108mm C: mm

ΛΑΜΑ/Plate: 70x6mm

ΤΡΥΠΕΣ/Holes Ø: (2) 12,5mm

(ΤΡΥΠΑ-ΤΡΥΠΑ)

/Hole - Hole distance: 44mm

00015801

ΚΩΔ./Code

3,16 €



MASCHIO L

ΠΡΟΣΑΡΜΟΓΗ/Fitting:
MASCHIO ML
OEM: 73100404 / 73100405

A: 182mm B: 116mm C: mm

ΛΑΜΑ/Plate: 60x6mm

ΤΡΥΠΕΣ/Holes Ø: (2) 12,5mm

(ΤΡΥΠΑ-ΤΡΥΠΑ)

/Hole - Hole distance: 40mm

00015834

ΚΩΔ./Code

3,07 €



ΑΜΒΛΕΙΑ (Blue)

MASCHIO B/BI/C/SC

ΠΡΟΣΑΡΜΟΓΗ/Fitting:
MASCHIO B/BI/C/SC
OEM: 01110426 / 01110427

A: 215mm B: 140mm C: 25mm

ΛΑΜΑ/Plate: 80x8mm

ΤΡΥΠΕΣ/Holes Ø: (2) 14,5mm

(ΤΡΥΠΑ-ΤΡΥΠΑ)

/Hole - Hole distance: 56mm

► Σημείωση: **Advanced Blue Power**

00013879

ΚΩΔ./Code

3,93 €

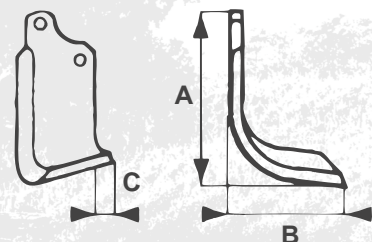

Σημείωση: *Συσκευασία 10 Δεξιά+10 Αριστερά σε χαρτοκιβώτιο

ΜΑΧΑΙΡΙΑ ΦΡΕΖΑΣ

Blades for tillers



(Blue)

KUHN

ΠΡΟΣΑΡΜΟΓΗ/Fitting: KUHN

A: 170mm B: 130mm C: mm

ΛΑΜΑ/Plate: 90x8mm

ΤΡΥΠΕΣ/Holes Ø: (2) 16,5mm

(ΤΡΥΠΑ-ΤΡΥΠΑ)

/Hole - Hole distance: 58mm

▶ Σημείωση: Advanced Blue Power

00013880

ΚΩΔ./Code

5,03 €



(Blue)

ΚΩΝΣΤΑΝΤΙΝΙΔΗ

ΠΡΟΣΑΡΜΟΓΗ/Fitting: ΤΥΠΟΥ ΚΩΝΣΤΑΝΤΙΝΙΔΗ ΥΠΕΡΒΑΡΕΟΥ

A: 170mm B: 130mm C: mm

ΛΑΜΑ/Plate: 90x8mm

ΤΡΥΠΕΣ/Holes Ø: (2) 16,5mm

(ΤΡΥΠΑ-ΤΡΥΠΑ)

/Hole - Hole distance: 58mm

▶ Σημείωση: Advanced Blue Power

00013881

ΚΩΔ./Code

5,37 €

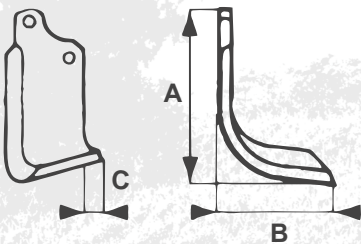

ΜΑΧΑΙΡΙΑ ΦΡΕΖΟΣΚΑΛΙΣΤΗΡΙΟΥ

Blades for tillers



ΠΡΟΣΑΡΜΟΓΗ/Fitting:

ΔΗΜΗΤΡΙΟΥ/ΨΑΛΤΙΔΗ

A: 140mm B: 70mm C: mm

ΛΑΜΑ/Plate: 50x6mm

ΤΡΥΠΕΣ/Holes Ø: (2) 11mm

(ΤΡΥΠΑ-ΤΡΥΠΑ)

/Hole - Hole distance: 35mm

00010118**

ΚΩΔ./Code

1,35 €

▶ **ΠΡΟΣΑΡΜΟΓΗ**

/Fitting:

ΤΣΑΛΑΠΑΤΑΡΑ

/ΨΑΛΤΙΔΗ

A: 125mm B: 60mm C: mm

ΛΑΜΑ/Plate: 55x6mm

ΤΡΥΠΕΣ/Holes Ø: (2) 10mm

(ΤΡΥΠΑ-ΤΡΥΠΑ)

/Hole - Hole distance: 33mm

00013356**

ΚΩΔ./Code

1,35 €

▶ **ΠΡΟΣΑΡΜΟΓΗ**

/Fitting: ΤΥΠΟΥ

ΤΟΥΡΚΙΑΣ

A: 130mm B: 60mm C: mm

ΛΑΜΑ/Plate: 55x6mm

ΤΡΥΠΕΣ/Holes Ø: (2) 12mm

(ΤΡΥΠΑ-ΤΡΥΠΑ)

/Hole - Hole distance: 38mm

00013357**

ΚΩΔ./Code

1,75 €

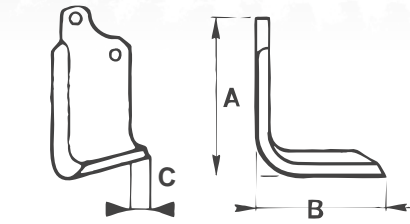

(Blue)

HOWARD ROTAVATOR

ΠΡΟΣΑΡΜΟΓΗ/Fitting:

HOWARD ROTAVATOR U-FRANCESE

A: 180mm B: 135mm C: mm

ΛΑΜΑ/Plate: 80x7mm

ΤΡΥΠΕΣ/Holes Ø: (2) 13,5mm

(ΤΡΥΠΑ-ΤΡΥΠΑ)

/Hole - Hole distance: 57mm

▶ Σημείωση: Advanced Blue Power

00013888*

ΚΩΔ./Code

3,42 €



(Blue)

CELLI

ΠΡΟΣΑΡΜΟΓΗ/Fitting:

CELLI E/HV/HF

A: 180mm B: 135mm C: mm

ΛΑΜΑ/Plate: 80x7mm

ΤΡΥΠΕΣ/Holes Ø: (2) 14,5mm

(ΤΡΥΠΑ-ΤΡΥΠΑ)

/Hole - Hole distance: 57mm

▶ Σημείωση: Advanced Blue Power

00013889*

ΚΩΔ./Code

3,42 €

Σημείωση: *Συσκευασία 10 Δεξιά+10 Αριστερά σε χαρτοκιβώτιο

Σημείωση: **Συσκευασία 20 Δεξιά+20 Αριστερά σε χαρτοκιβώτιο

ΜΑΧΑΙΡΙ ΦΡΕΖΟΣΚΑΛΙΣΤΗΡΙΟΥ

Blade for tillers

► ΠΡΟΣΑΡΜΟΓΗ
/Fitting: ΤΣΙΚΟΥ



A: 140mm B: 90mm C: mm
ΛΑΜΑ/Plate: 60x6mm
ΤΡΥΠΕΣ/Holes Ø: (2) 12mm
(ΤΡΥΠΑ-ΤΡΥΠΑ)
/Hole - Hole distance: 35mm

00013878
ΚΩΔ./Code **1,93** €



ΣΚΑΠΤΙΚΟΥ
DONDI

ΠΡΟΣΑΡΜΟΓΗ/Fitting:
ΣΚΑΠΤΙΚΟΥ DONDI (ΓΩΝΙΑΚΟ)

A: 180mm B: 110mm C: mm
ΛΑΜΑ/Plate: 75x7mm
ΤΡΥΠΕΣ/Holes Ø: (2) 12mm
(ΤΡΥΠΑ-ΤΡΥΠΑ)
/Hole - Hole distance: 40mm

00012689
ΚΩΔ./Code **3,01** €



ΣΚΑΠΤΙΚΟΥ
BENASSI

ΠΡΟΣΑΡΜΟΓΗ/Fitting:
ΣΚΑΠΤΙΚΟΥ BENASSI ΒΑΡΕΟΥ ΤΥΠΟΥ

A: 210mm B: 70mm C: mm
ΛΑΜΑ/Plate: 50x6mm
ΤΡΥΠΕΣ/Holes Ø: (2) 10,5mm
(ΤΡΥΠΑ-ΤΡΥΠΑ)
/Hole - Hole distance: 68mm

00012691
ΚΩΔ./Code **2,04** €

ΜΑΧΑΙΡΙΑ ΣΚΑΠΤΙΚΩΝ

Blades for tillers



GOLDONI

ΠΡΟΣΑΡΜΟΓΗ/Fitting:
GOLDONI 150

A: 145mm B: 105mm C: mm
ΛΑΜΑ/Plate: 60x6mm
ΤΡΥΠΕΣ/Holes Ø: (2) 10,5mm
(ΤΡΥΠΑ-ΤΡΥΠΑ)
/Hole - Hole distance: 40,5mm

00012680
ΚΩΔ./Code **2,48** €



GOLDONI

ΠΡΟΣΑΡΜΟΓΗ/Fitting:
GOLDONI G10D

A: 200mm B: 75mm C: mm
ΛΑΜΑ/Plate: 44x5mm
ΤΡΥΠΕΣ/Holes Ø: (2) 10,5mm
(ΤΡΥΠΑ-ΤΡΥΠΑ)
/Hole - Hole distance: 80mm

00012681
ΚΩΔ./Code **1,75** €



SEP/FERRARI

ΠΡΟΣΑΡΜΟΓΗ/Fitting:
SEP 1300/2000/ FERRARI

A: 130mm B: 55mm C: mm
ΛΑΜΑ/Plate: 40x5mm
ΤΡΥΠΕΣ/Holes Ø: (2) 10,5mm
(ΤΡΥΠΑ-ΤΡΥΠΑ)
/Hole - Hole distance: 28mm

00012685
ΚΩΔ./Code **1,57** €

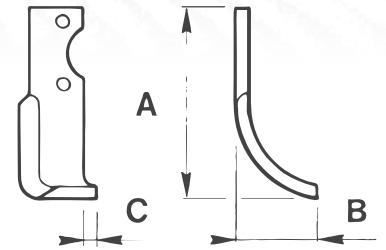

ΑΜΠΕΛΟΥΡΓΙΚΗΣ

ΠΡΟΣΑΡΜΟΓΗ/Fitting:
ΠΑΤΗ/ΠΥΘΑΓΟΡΑ/ΚΟΥΤΣΙΚΟΥ

A: 180mm B: 120mm C: mm
ΛΑΜΑ/Plate: 75x6mm
ΤΡΥΠΕΣ/Holes Ø: (2) 13mm
(ΤΡΥΠΑ-ΤΡΥΠΑ)
/Hole - Hole distance: 65mm

00012687
ΚΩΔ./Code **2,92** €



ΑΓΡΙΑ

ΠΡΟΣΑΡΜΟΓΗ/Fitting:
ΑΓΡΙΑ MASTER

A: 190mm B: 70mm C: mm
ΛΑΜΑ/Plate: 30x5mm
ΤΡΥΠΕΣ/Holes Ø: (2) 9,5mm
(ΤΡΥΠΑ-ΤΡΥΠΑ)
/Hole - Hole distance: 70mm

00012688
ΚΩΔ./Code **1,56** €

ΜΑΧΑΙΡΙΑ ΣΚΑΠΤΙΚΟΥ

Blade for tillers



SEP

ΠΡΟΣΑΡΜΟΓΗ/Fitting: SEP 70

A: 190mm B: 70mm C: mm

ΛΑΜΑ/Plate: 35x5mm

ΤΡΥΠΕΣ/Holes Ø: (2) 10,5mm

(ΤΡΥΠΑ-ΤΡΥΠΑ)

/Hole - Hole distance: 70mm

00012690

ΚΩΔ./Code

1,56 €



**ΣΚΑΠΤΙΚΟΥ
BCS/SEP**

ΠΡΟΣΑΡΜΟΓΗ/Fitting:

ΣΚΑΠΤΙΚΟΥ BCS 715 / SEP 1000

A: 170mm B: 55mm C: mm

ΛΑΜΑ/Plate: 30x5mm

ΤΡΥΠΕΣ/Holes Ø: (2) 9mm

(ΤΡΥΠΑ-ΤΡΥΠΑ)

/Hole - Hole distance: 55mm

00012684

ΚΩΔ./Code

1,56 €

ΜΑΧΑΙΡΙ ΚΑΔΕΝΑΣ ΣΚΑΠΤΙΚΗΣ

Blade for digging chain



SET (R-L)

ΜΗΚΟΣ/Length: 105/130mm

ΠΛΑΤΟΣ/Width: 90mm

ΛΑΜΑ/Plate: 8mm

ΤΡΥΠΕΣ/Holes Ø: (2) 17mm

(ΤΡΥΠΑ-ΤΡΥΠΑ)/Hole - Hole: 50mm

00017177

ΚΩΔ./Code

3,70 €

ΜΑΧΑΙΡΙΑ ΦΡΕΖΑΣ

KUBOTA-ISEKI

Blade for tillers



ΠΡΟΣΑΡΜΟΓΗ/Fitting:

KUBOTA-ISEKI

A: 180mm B: 25mm C: mm

ΛΑΜΑ/Plate: 25x10mm

ΤΡΥΠΑ/Holes Ø: 10,5mm

00010545**

ΚΩΔ./Code

2,00 €



ΠΡΟΣΑΡΜΟΓΗ/Fitting:

KUBOTA-ISEKI

A: 200mm B: 30mm C: mm

ΛΑΜΑ/Plate: 25x9mm

ΤΡΥΠΑ/Holes Ø: 10,5mm

00012692*

ΚΩΔ./Code

2,79 €



ΠΡΟΣΑΡΜΟΓΗ/Fitting:

KUBOTA-ISEKI

A: 200mm B: 30mm C: mm

ΛΑΜΑ/Plate: 25x7mm

ΤΡΥΠΑ/Holes Ø: 10,5mm

00012693*

ΚΩΔ./Code

2,42 €

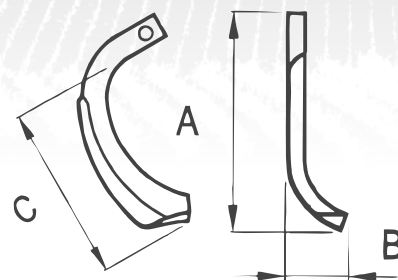

ΠΡΟΣΑΡΜΟΓΗ/Fitting:

KUBOTA-ISEKI

A: 186mm B: 50mm C: mm

ΛΑΜΑ/Plate: 25x9mm

ΤΡΥΠΑ/Holes Ø: 10,5mm

00012695*

ΚΩΔ./Code

2,00 €



ΠΡΟΣΑΡΜΟΓΗ/Fitting:

KUBOTA-ISEKI

A: 195mm B: 40mm C: mm

ΛΑΜΑ/Plate: 23x8mm

ΤΡΥΠΑ/Holes Ø: 10,5mm

00012696*

ΚΩΔ./Code

1,89 €



ΠΡΟΣΑΡΜΟΓΗ/Fitting:

MINI KUBOTA-ISEKI

A: 160mm B: 50mm C: mm

ΛΑΜΑ/Plate: 22x6mm

ΤΡΥΠΑ/Holes Ø: 10,5mm

00012697*

ΚΩΔ./Code

1,62 €

Σημείωση: *Συσκευασία 10 Δεξιά+10 Αριστερά σε χαρτοκιβώτιο

Σημείωση: **Συσκευασία 20 Δεξιά+20 Αριστερά σε χαρτοκιβώτιο

ΜΑΧΑΙΡΙΑ ΣΒΟΛΟΚΟΠΤΗ

Rotary harrow tines



ΠΡΟΣΑΡΜΟΓΗ/Fitting:
MASCHIO, VIGOLO

A: 280mm B: 90mm C: 12mm
(Φ) **ΤΡΥΠΕΣ**/Holes Ø: (2) 17mm
(D) **(ΤΡΥΠΑ-ΤΡΥΠΑ)**
/Hole - Hole distance: 50mm

ΔΕΞΙ/Right

00012145
ΚΩΔ./Code

7,00 €

ΑΡΙΣΤΕΡΟ/Left

00012256
ΚΩΔ./Code

7,00 €



ΠΡΟΣΑΡΜΟΓΗ/Fitting:
MASCHIO, VIGOLO

A: 300mm B: 100mm C: 12mm
(Φ) **ΤΡΥΠΕΣ**/Holes Ø: (2) 17mm
(D) **(ΤΡΥΠΑ-ΤΡΥΠΑ)**
/Hole - Hole distance: 60mm

ΔΕΞΙ/Right

00012146
ΚΩΔ./Code

8,00 €

ΑΡΙΣΤΕΡΟ/Left

00012257
ΚΩΔ./Code

8,00 €

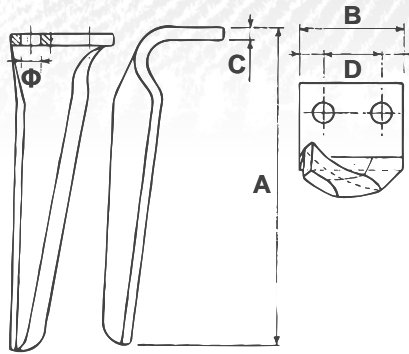

ΠΡΟΣΑΡΜΟΓΗ/Fitting: POTTINGER
OEM: 8762400200

A: 335mm B: 110mm C: 15mm
(Φ) **ΤΡΥΠΕΣ**/Holes Ø: (1) 26,3mm

ΔΕΞΙ/Right

00019441
ΚΩΔ./Code

18,90 €

ΑΡΙΣΤΕΡΟ/Left

00019441
ΚΩΔ./Code

18,90 €

ΜΑΧΑΙΡΙ ΚΑΤΑΣΤΡΟΦΕΑ ΚΑΛΑΜΠΟΚΑ

Stalk chopper blade (Corn)



ΠΡΟΣΑΡΜΟΓΗ/Fitting: FANTINI
OEM: 13739

ΜΗΚΟΣ/Length: 290mm

ΠΛΑΤΟΣ/Width: 60mm

ΠΑΧΟΣ/Thickness: 6mm

ΤΡΥΠΑ/Hole : 30mm

00018736
ΚΩΔ./Code

12,00 €

ΜΑΧΑΙΡΙΑ ΣΤΕΛΕΧΟΚΟΠΤΗ

Finishing mower blades



ΜΗΚΟΣ/Length: 290mm

ΠΛΑΤΟΣ/Width: 80mm

ΠΑΧΟΣ/Thickness: 8mm

ΤΡΥΠΑ/Hole Ø: 30mm

00018811
ΚΩΔ./Code

7,00 €



ΜΗΚΟΣ/Length: 600mm

ΠΛΑΤΟΣ/Width: 80mm

ΠΑΧΟΣ/Thickness: 10mm

ΤΡΥΠΑ/Hole Ø: 20,5mm

00018809
ΚΩΔ./Code

14,00 €



ΜΗΚΟΣ/Length: 600mm

ΠΛΑΤΟΣ/Width: 60mm

ΠΑΧΟΣ/Thickness: 12mm

ΤΡΥΠΑ/Hole Ø: 20,5mm

00018810
ΚΩΔ./Code

13,00 €

ΜΑΧΑΙΡΙΑ ΚΑΤΑΣΤΡΟΦΕΑ

Flail mower blades



ΠΡΟΣΑΡΜΟΓΗ/Fitting: CELLI
ΤΥΠΟΣ/Type: ΙΣΙΟ/Straight

A: 120mm B: 50mm C: 10mm
ΤΡΥΠΑ/Hole Ø: 16,5mm

00014879
ΚΩΔ./Code **2,86** €

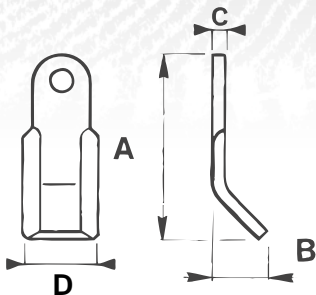

ΠΡΟΣΑΡΜΟΓΗ/Fitting: MASCHIO,
ZAPPATOR
ΤΥΠΟΣ/Type: ΚΥΡΤΟ/Curved

A: 120mm B: 70mm
C: 10mm D: 60mm
ΤΡΥΠΑ/Hole Ø: 20,5mm

00014881
ΚΩΔ./Code **2,92** €



ΠΡΟΣΑΡΜΟΓΗ/Fitting: DRAGONE
ΤΥΠΟΣ/Type: ΚΥΡΤΟ/Curved

A: 110mm B: 38mm
C: 10mm D: 40mm
ΤΡΥΠΑ/Hole Ø: 18,5mm

00014886
ΚΩΔ./Code **2,23** €

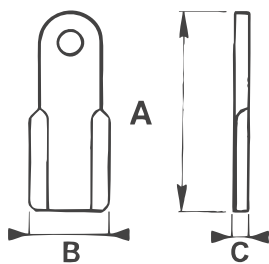

ΠΡΟΣΑΡΜΟΓΗ/Fitting: KUHN, NOBILI,
BREVIGLIERI, OMARV, VOGEL NOOT
ΤΥΠΟΣ/Type: ΙΣΙΟ/Straight

A: 204mm B: 60mm C: 10mm
ΤΡΥΠΑ/Hole Ø: 25,5mm

00014884
ΚΩΔ./Code **3,18** €



ΠΡΟΣΑΡΜΟΓΗ/Fitting: CELLI
ΤΥΠΟΣ/Type: ΚΥΡΤΟ/Curved

A: 120mm B: 55mm
C: 10mm D: 50mm
ΤΡΥΠΑ/Hole Ø: 16,5mm

00014878
ΚΩΔ./Code **2,40** €



ΠΡΟΣΑΡΜΟΓΗ/Fitting: AGRIMASTER,
AGROMEC, CALDERONI, FORIGO,
ROTERTALIA, MURATORI, ORSI, ZANON
ΤΥΠΟΣ/Type: ΚΥΡΤΟ/Curved

A: 120mm B: 55mm
C: 8mm D: 40mm
ΤΡΥΠΑ/Hole Ø: 20,5mm

00014883
ΚΩΔ./Code **1,86** €



ΠΡΟΣΑΡΜΟΓΗ/Fitting: KUHN,
ΜΕΑΑΤ, NOBILI, OMARV, QUIVOGNE
ΤΥΠΟΣ/Type: ΓΩΝΙΑΚΟ/Curved

A: 205mm B: 55mm
C: 10mm D: 60mm
ΤΡΥΠΑ/Hole Ø: 25,5mm

00014882
ΚΩΔ./Code **3,18** €



ΠΡΟΣΑΡΜΟΓΗ/Fitting: DRAGONE
ΤΥΠΟΣ/Type: ΚΥΡΤΟ/Curved

A: 140mm B: 72mm
C: 8mm D: 50mm
ΤΡΥΠΑ/Hole Ø: 18,5mm

00014885
ΚΩΔ./Code **2,23** €



ΠΡΟΣΑΡΜΟΓΗ/Fitting: MASCHIO
ΤΥΠΟΣ/Type: ΚΥΡΤΟ/Curved

A: 210mm B: 61mm
C: 8mm D: 60mm
ΤΡΥΠΑ/Hole Ø: 25,5mm

00014880
ΚΩΔ./Code **3,07** €

ΣΦΥΡΙΑ ΚΑΤΑΣΤΡΟΦΕΑ

Flail mower hammers

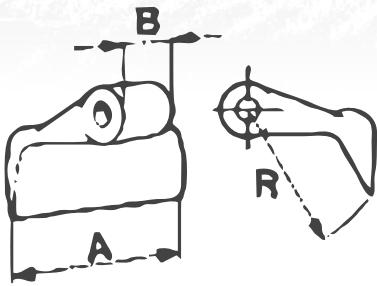

ΤΥΠΟΣ/Type: RM8/EM8/AZ08
ΠΡΟΣΑΡΜΟΓΗ/Fitting: AGRICOM,
 BECCHIO & MANDRILE, CABE,
 SAUERBURGER, ZANON, ZAPPATOR

A: 120mm B: 40mm R: 90mm
ΤΡΥΠΑ/Hole Ø: 20,5mm

00010888
ΚΩΔ./Code 7,00 €



ΤΥΠΟΣ/Type: AZCH3
ΠΡΟΣΑΡΜΟΓΗ/Fitting: Χιώτms Νο3

A: 80mm B: 35mm R: 95mm
ΤΡΥΠΑ/Hole Ø: 20,5mm

00019037
ΚΩΔ./Code 6,20 €



ΤΥΠΟΣ/Type: RM6/EM6/AZ6
ΠΡΟΣΑΡΜΟΓΗ/Fitting: AGRICOM,
 BERTI, BREVIGLIERI, M.E.A.A.T., OEHLER,
 VIGOLO, VOGEL & NOOT

A: 137mm B: 40mm R: 95mm
ΤΡΥΠΑ/Hole Ø: 16,5mm

00019080
ΚΩΔ./Code 8,30 €



ΤΥΠΟΣ/Type: RM6/EM6/AZ06
ΠΡΟΣΑΡΜΟΓΗ/Fitting: BERTI

A: 137mm B: 40mm R: 95mm
ΤΡΥΠΑ/Hole Ø: 20,5mm

00019081
ΚΩΔ./Code 8,30 €



ΤΥΠΟΣ/Type: RM32/EM32/AZ32
ΠΡΟΣΑΡΜΟΓΗ/Fitting: ΚΩΝΣΤΑΝΤΙΝΙΔΗ,
 FEHRENBACH, HMF FREI

A: 75mm B: 22mm R: 95mm
ΤΡΥΠΑ/Hole Ø: 16,5mm

00019083
ΚΩΔ./Code 5,00 €



ΤΥΠΟΣ/Type: RM33/EM37/AZ37
ΠΡΟΣΑΡΜΟΓΗ/Fitting: ACMA, AGRIMASTER,
 CONCEPT PERUGINI, MASCHIO, OMARV,
 SICMA, TIERRE, UBALD

A: 85mm B: 40mm R: 100mm
ΤΡΥΠΑ/Hole Ø: 16,5mm

00019082
ΚΩΔ./Code 4,80 €

ΣΦΥΡΙΑ ΚΑΤΑΣΤΡΟΦΕΑ

Flail mower hammers

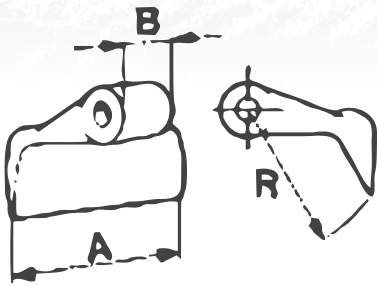

ΤΥΠΟΣ/Type: RM10/EM10/AZ10
ΠΡΟΣΑΡΜΟΓΗ/Fitting: AGRICOM,
 AGRIMASTER, AGROMEC, CALDERONI,
 FALCONERO, MASCHIO, MURATORI,
 ORSI, SICMA, ZANON, ZAPPATOR

A: 150mm B: 55mm R: 100mm
ΤΡΥΠΑ/Hole Ø: 20,5mm

00019474
ΚΩΔ./Code

8,10 €



ΤΥΠΟΣ/Type: RM36/EM28/AZ28
ΠΡΟΣΑΡΜΟΓΗ/Fitting: DRAGONE

A: 100mm B: 74mm R: 100mm
ΤΡΥΠΑ/Hole : 18,5mm

00019475
ΚΩΔ./Code

8,00 €



ΤΥΠΟΣ/Type: RM8/EM8/AZ08
ΠΡΟΣΑΡΜΟΓΗ/Fitting: GESTIN,
 HUMUS, MASCHIO, SAUERBURGER,
 TERRAL

A: 150mm B: 60mm R: 90mm
ΤΡΥΠΑ/Hole Ø: 20,5mm

00019476
ΚΩΔ./Code

8,00 €



ΤΥΠΟΣ/Type: RM8/EM8/AZ08
ΠΡΟΣΑΡΜΟΓΗ/Fitting: AGRICOM,
 BECCHIO & MANDRILE, CABE,
 SAUERBURGER, ZANON, ZAPPATOR

A: 120mm B: 40mm R: 90mm
ΤΡΥΠΑ/Hole Ø: 16,5mm

00019477
ΚΩΔ./Code

7,00 €

ΚΑΡΔΙΕΣ ΚΑΛΛΙΕΡΓΗΤΩΝ

Molded shares

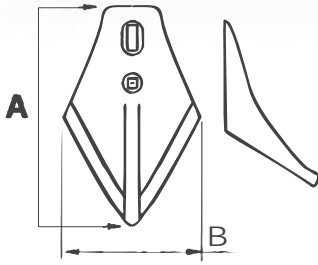

ΤΥΠΟΣ: ΣΤΑΜΠΑΡΙΣΤΗ/ΓΙΑ RIPPER

A: mm B: 140mm
ΠΑΧΟΣ/Thickness: 10mm
ΤΡΥΠΕΣ/Holes Ø: (2)
 12x12mm / 14x23mm

00011769 
 ΚΩΔ./Code



ΤΥΠΟΣ: ΣΤΑΜΠΑΡΙΣΤΗ/ΓΙΑ RIPPER

A: 240mm B: 130mm
ΠΑΧΟΣ/Thickness: 10mm
ΤΡΥΠΕΣ/Hole Ø: (2)
 12x12mm / 14x23mm

00002049 
 ΚΩΔ./Code

ΧΕΛΙΔΟΝΕΣ ΚΑΛΛΙΕΡΓΗΤΩΝ

Molded shares



ΤΥΠΟΣ: ΧΩΡΙΣ ΦΤΕΡΑ/ΓΙΑ RIPPER /ΣΤΑΜΠΑΡΙΣΤΗ

A: mm B: 200mm
ΠΑΧΟΣ/Thickness: 10mm
ΤΡΥΠΕΣ/Holes Ø: (2)
 14x14mm / 14x23mm
(ΤΡΥΠΑ-ΤΡΥΠΑ)/Hole - Hole: 55mm

00011426 
 ΚΩΔ./Code



ΤΥΠΟΣ: ΜΕ ΦΤΕΡΑ/ΓΙΑ RIPPER /ΣΤΑΜΠΑΡΙΣΤΗ

A: 240mm B: 200mm
ΠΑΧΟΣ/Thickness: 10mm
ΤΡΥΠΕΣ/Hole Ø: (2)
 13x13mm / 13x22mm

00002047 
 ΚΩΔ./Code

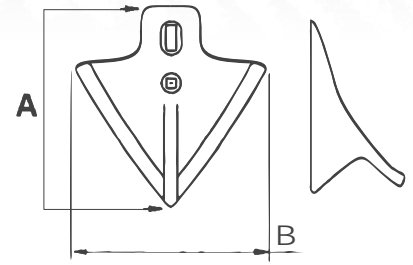
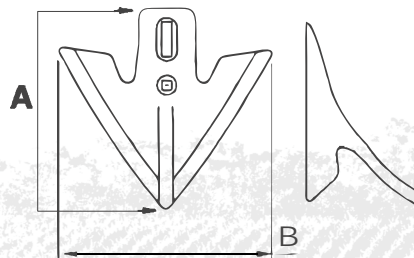

ΤΥΠΟΣ: ΓΙΑΝΝΙΚΗ ΣΤΑΜΠΑΡΙΣΤΗ

A: 270mm B: 180mm
ΠΑΧΟΣ/Thickness: 10mm
ΤΡΥΠΕΣ/Hole Ø: (2)
 10x10mm

00005802 
 ΚΩΔ./Code



ΤΥΠΟΣ: ΧΑΛΚΙΔΙΚΗ ΣΤΑΜΠΑΡΙΣΤΗ

A: 280mm B: 180mm
ΠΑΧΟΣ/Thickness: 10mm
ΤΡΥΠΕΣ/Hole Ø: (2)
 12x12mm / 12x21mm

00005803 
 ΚΩΔ./Code

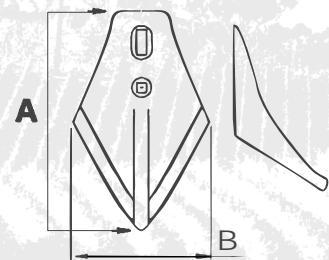

ΚΑΡΔΙΕΣ ΚΑΛΛΙΕΡΓΗΤΩΝ

Vibrotiller shares

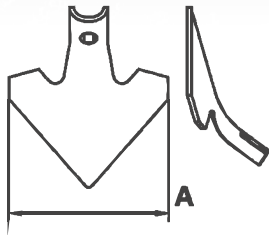

ΤΥΠΟΣ: ΧΩΡΙΣ ΦΤΕΡΑ/ΓΙΑ FLEX

A: 105mm

ΠΑΧΟΣ/Thickness: 4mm

ΤΡΥΠΑ/Hole Ø: 10,5mm

00010113

ΚΩΔ./Code

2,25 €



ΤΥΠΟΣ: ΧΩΡΙΣ ΦΤΕΡΑ/ΓΙΑ FLEX

A: 150mm

ΠΑΧΟΣ/Thickness: 4mm

ΤΡΥΠΑ/Holes Ø: 10,5mm

00010114

ΚΩΔ./Code

2,90 €



ΤΥΠΟΣ: ΧΩΡΙΣ ΦΤΕΡΑ/ΓΙΑ FLEX

A: 175mm

ΠΑΧΟΣ/Thickness: 4mm

ΤΡΥΠΑ/Hole Ø: 10,5mm

00010738

ΚΩΔ./Code

3,10 €

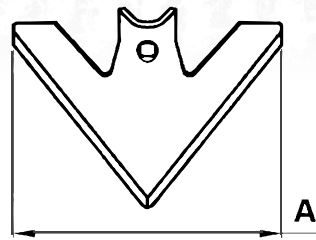

ΤΥΠΟΣ: ΜΕ ΦΤΕΡΑ/ΓΙΑ FLEX

A: 200mm

ΠΑΧΟΣ/Thickness: 4mm

ΤΡΥΠΑ/Hole Ø: 10,5mm

00011767

ΚΩΔ./Code

3,65 €



ΤΥΠΟΣ: ΜΕ ΦΤΕΡΑ/ΓΙΑ FLEX

A: 250mm

ΠΑΧΟΣ/Thickness: 4mm

ΤΡΥΠΑ/Hole Ø: 10,5mm

00011768

ΚΩΔ./Code

4,00 €



ΝΥΧΙΑ ΚΑΛΛΙΕΡΓΗΤΩΝ

Reversible socs



ΠΡΟΣΑΡΜΟΓΗ/Fitting:

FLEX: 32x10

A: 190mm

ΛΑΜΑ/Plate: 40x6mm

ΤΡΥΠΑ/Hole Ø: 10,5mm

00010115

ΚΩΔ./Code

1,05 €



ΠΡΟΣΑΡΜΟΓΗ/Fitting:

FLEX: 32x10 / 45x12

A: 210mm

ΛΑΜΑ/Plate: 40x8mm

ΤΡΥΠΑ/Hole Ø: 10,5mm

00018962

ΚΩΔ./Code

2,00 €



ΠΡΟΣΑΡΜΟΓΗ/Fitting:

FLEX: 45x12

A: 250mm

ΛΑΜΑ/Plate: 55x6mm

ΤΡΥΠΑ/Hole Ø: 10mm

00013355

ΚΩΔ./Code

3,40 €

ΣΥΝΔΕΤΗΡΕΣ ΚΑΛΛΙΕΡΓΗΤΩΝ

Flex vibrotiller tine frames



ΤΥΠΟΣ/Type: ΛΑΜΑΣ | (Single)
ΠΡΟΣΑΡΜΟΓΗ/Fitting: FLEX: 32x10

ΛΑΜΑ/Plate: 50x12mm
ΤΡΥΠΑ/Hole Ø: 13mm

00012670
ΚΩΔ./Code **1,30** €



ΤΥΠΟΣ/Type: ΛΑΜΑΣ || (Double)
ΠΡΟΣΑΡΜΟΓΗ/Fitting: FLEX: 32x10

ΛΑΜΑ/Plate: 50x12mm
ΤΡΥΠΑ/Hole Ø: 13mm

00012671
ΚΩΔ./Code **1,50** €



ΤΥΠΟΣ/Type: ΚΟΙΛΟΔΟΚΟΥ | (Single)
ΠΡΟΣΑΡΜΟΓΗ/Fitting: FLEX: 32x10

ΛΑΜΑ/Plate: 50x50mm
ΤΡΥΠΑ/Hole Ø: 13mm

00012672
ΚΩΔ./Code **1,98** €



ΤΥΠΟΣ/Type: ΚΟΙΛΟΔΟΚΟΥ | (Single)
ΠΡΟΣΑΡΜΟΓΗ/Fitting: FLEX: 32x12

ΛΑΜΑ/Plate: 50x50mm
ΤΡΥΠΑ/Hole Ø: 13mm

00012673
ΚΩΔ./Code **1,98** €



ΤΥΠΟΣ/Type: ΚΟΙΛΟΔΟΚΟΥ | (Single)
ΠΡΟΣΑΡΜΟΓΗ/Fitting: FLEX: 32x10

ΛΑΜΑ/Plate: 50x50mm
ΤΡΥΠΑ/Hole Ø: 13mm

00012674
ΚΩΔ./Code **1,85** €



ΤΥΠΟΣ: 1 ΤΡΥΠΑ/ΣΚΕΤΟ ΧΩΡΙΣ ΝΥΧΙ

ΜΗΚΟΣ Α (ΑΠΟ ΣΥΝΔΕΤΗΡΑ Κ ΚΑΤΩ)
/Length A: 520mm

ΜΗΚΟΣ ΟΛΙΚΟ/Total Length: 670mm

ΠΛΑΤΟΣ/Width: 300mm

ΛΑΜΑ/Plate: 45x12mm

ΤΡΥΠΕΣ/Holes Ø: 14,5 / 12mm

00019581
ΚΩΔ./Code **18,00** €

ΕΛΑΣΜΑΤΑ ΚΑΛΛΙΕΡΓΗΤΩΝ

Springs for vibrotiller



ΤΥΠΟΣ: ΙΣΙΟ / ΣΚΕΤΟ ΧΩΡΙΣ ΝΥΧΙ

ΜΗΚΟΣ Α (ΑΠΟ ΣΥΝΔΕΤΗΡΑ Κ ΚΑΤΩ)
/Length A: 390mm

ΜΗΚΟΣ ΟΛΙΚΟ/Total Length: 510mm

ΠΛΑΤΟΣ/Width: 225mm

ΛΑΜΑ/Plate: 32x12mm

00014774
ΚΩΔ./Code **11,80** €



ΤΥΠΟΣ: ΣΚΕΤΟ ΧΩΡΙΣ ΝΥΧΙ

ΜΗΚΟΣ ΟΛΙΚΟ/Total Length: 540mm

ΠΛΑΤΟΣ/Width: 300mm

ΛΑΜΑ/Plate: 32x10mm

00019580
ΚΩΔ./Code **9,90** €

ΝΥΧΙΑ ΚΑΛΛΙΕΡΓΗΤΩΝ

Reversible socs

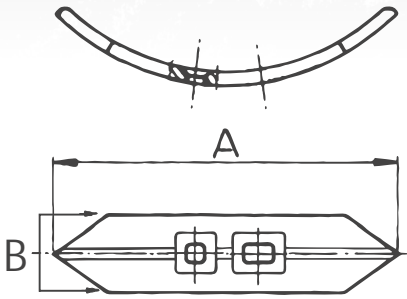

ΠΡΟΣΑΡΜΟΓΗ/Fitting: ΣΤΑΒΑΡΙ
ΣΠΕΙΡΩΤΟΥ: 25x25 / 30x30

A: 280mm B: 65mm
ΠΑΧΟΣ/Thickness: 10mm
ΤΡΥΠΕΣ/Holes Ø: (2)
13x13mm / 13x23mm

00002058  **5,30** €
ΚΩΔ./Code

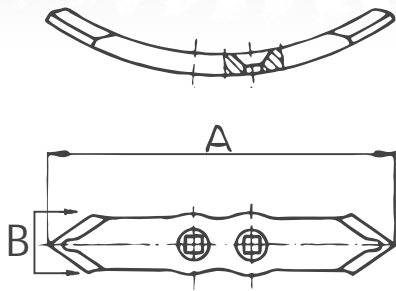

ΠΡΟΣΑΡΜΟΓΗ/Fitting: ΣΤΑΒΑΡΙ
ΣΠΕΙΡΩΤΟΥ: 30x30

A: 270mm B: 40mm
ΠΑΧΟΣ/Thickness: 16mm
ΤΡΥΠΕΣ/Holes Ø: (2) 14x14mm
(**ΤΡΥΠΑ-ΤΡΥΠΑ**)/Hole - Hole: 45mm

00013353  **4,00** €
ΚΩΔ./Code

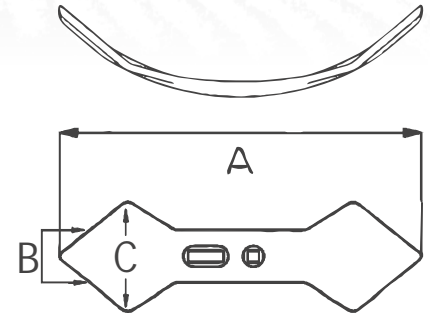

ΠΡΟΣΑΡΜΟΓΗ/Fitting: CHISEL
(ΔΙΠΛΗΣ ΚΑΡΔΙΑΣ)

A: 440mm B: 55mm C: 130mm
ΠΑΧΟΣ/Thickness: 15mm
ΤΡΥΠΕΣ/Holes : (2) 13,5/13,5x44mm
(**ΤΡΥΠΑ-ΤΡΥΠΑ**)/Hole - Hole: 75mm

00002050  **13,00** €
ΚΩΔ./Code

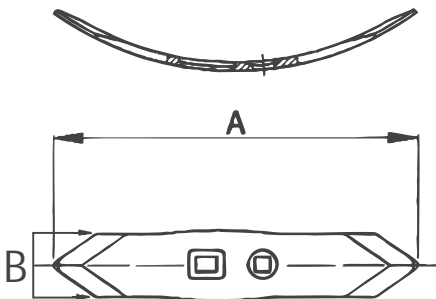

ΠΡΟΣΑΡΜΟΓΗ/Fitting: ΣΤΑΒΑΡΙ
ΣΠΕΙΡΩΤΟΥ: 30x30

A: 280mm B: 60mm
ΠΑΧΟΣ/Thickness: 12mm
ΤΡΥΠΕΣ/Holes Ø: (2)
14x14mm / 14x20mm
(**ΤΡΥΠΑ-ΤΡΥΠΑ**)/Hole - Hole: 45mm

00013876  **4,60** €
ΚΩΔ./Code



ΠΡΟΣΑΡΜΟΓΗ/Fitting: ΣΤΑΒΑΡΙ
ΣΠΕΙΡΩΤΟΥ: 30x30

A: 270mm B: 50mm
ΠΑΧΟΣ/Thickness: 16mm
ΤΡΥΠΕΣ/Holes Ø: (2) 15x15mm
(**ΤΡΥΠΑ-ΤΡΥΠΑ**)/Hole - Hole: 45mm

00010116  **5,05** €
ΚΩΔ./Code

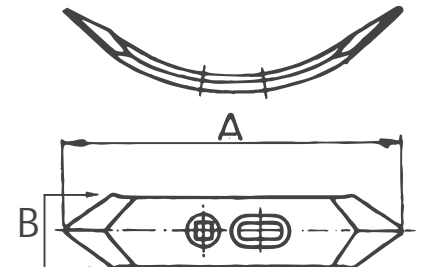

ΠΡΟΣΑΡΜΟΓΗ/Fitting: CHISEL

A: 350mm B: 60mm
ΠΑΧΟΣ/Thickness: 16mm
ΤΡΥΠΕΣ/Holes Ø: (2) 15/15x38mm(OBAΛ)
(**ΤΡΥΠΑ-ΤΡΥΠΑ**)/Hole - Hole: 45mm

00012056  **8,50** €
ΚΩΔ./Code

ΝΥΧΙΑ ΚΑΛΛΙΕΡΓΗΤΩΝ

Reversible socs

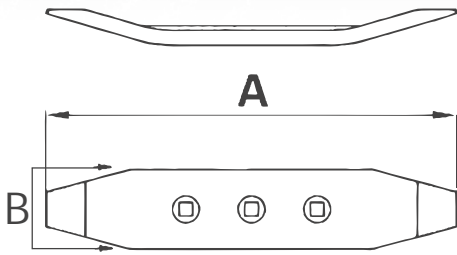

ΠΡΟΣΑΡΜΟΓΗ/Fitting: ΣΤΑΒΑΡΙ
RIPUNTATORE (ΥΠΕΡ)ΒΑΡΕΟΥ

A: 420mm B: 78mm
ΠΑΧΟΣ/Thickness: 20mm
ΤΡΥΠΕΣ/Holes Ø: (3) 12,5mm
(ΤΡΥΠΑ-ΤΡΥΠΑ) A/Hole - Hole: 65mm
(ΤΡΥΠΑ-ΤΡΥΠΑ) B/Hole - Hole: 130mm

00006446
ΚΩΔ./Code **17,00 €**

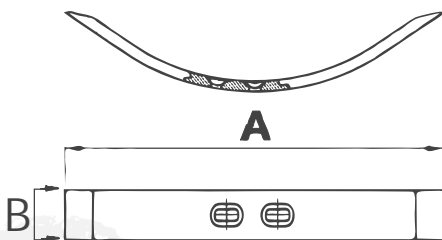

ΠΡΟΣΑΡΜΟΓΗ/Fitting: RIPUNTATORE
ΕΛΑΦΡΙΟΥ / ΜΕΣΑΙΟΥ / ΒΑΡΕΟΥ

A: 330mm B: 65mm
ΠΑΧΟΣ/Thickness: 16mm
ΤΡΥΠΕΣ/Holes : (2) ΟΒΑΛ
(ΤΡΥΠΑ-ΤΡΥΠΑ) A/Hole - Hole: 60mm

00008351
ΚΩΔ./Code **9,50 €**

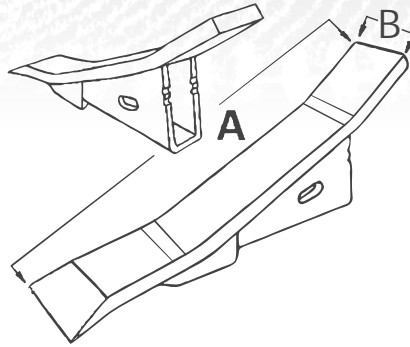

ΠΡΟΣΑΡΜΟΓΗ/Fitting: RIPUNTATORE
ALPEGO CRAKER (ΜΕ ΘΗΚΗ)

A: 400mm B: 70mm
ΠΑΧΟΣ/Thickness: 15mm

00016795
ΚΩΔ./Code **30,00 €**

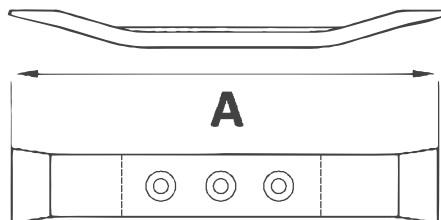

ΠΡΟΣΑΡΜΟΓΗ/Fitting: ΣΤΑΒΑΡΙ
RIPUNTATORE (ΥΠΕΡ)ΒΑΡΕΟΥ / ΦΑΡΔΥ

A: 440mm B: 75mm
ΠΑΧΟΣ/Thickness: 18mm
ΤΡΥΠΕΣ/Holes Ø: (3)
(ΤΡΥΠΑ-ΤΡΥΠΑ) A/Hole - Hole: 65mm
(ΤΡΥΠΑ-ΤΡΥΠΑ) B/Hole - Hole: 130mm

00015453
ΚΩΔ./Code **14,00 €**

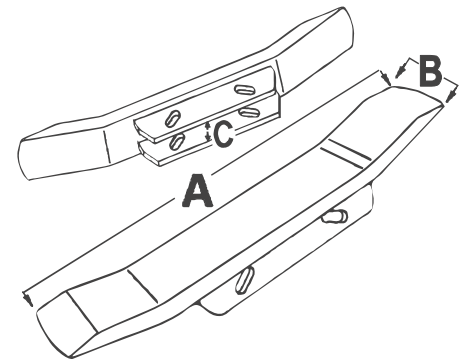

ΠΡΟΣΑΡΜΟΓΗ/Fitting: RIPUNTATORE
MASCHIO, GASPARDO ATTLA, PINOCCHIO
(ΜΕ ΒΑΣΗ)

A: 460mm B: 70mm C: 37mm
ΠΑΧΟΣ/Thickness: 20mm

00016796
ΚΩΔ./Code **30,00 €**

ΠΤΕΡΥΓΙΑ ΣΚΑΛΙΣΤΗΡΙΩΝ

Row crop wing shares

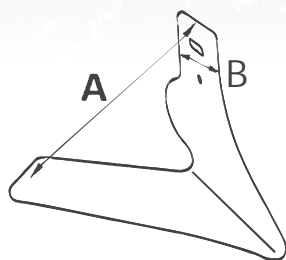

ΠΡΟΣΑΡΜΟΓΗ/Fitting: (Right)
ΣΚΑΛΙΣΤΗΡΙΟΥ ΔΕΞΙΟ

A: 180mm B: 60mm
ΠΑΧΟΣ/Thickness: 5mm
ΤΡΥΠΕΣ/Holes Ø: (2) 11mm
(**ΤΡΥΠΑ-ΤΡΥΠΑ**)/Hole - Hole: 33mm

00013359 
ΚΩΔ./Code 10,00 €



ΠΡΟΣΑΡΜΟΓΗ/Fitting: (Left)
ΣΚΑΛΙΣΤΗΡΙΟΥ ΑΡΙΣΤΕΡΟ

A: 180mm B: 60mm
ΠΑΧΟΣ/Thickness: 5mm
ΤΡΥΠΕΣ/Holes Ø: (2) 11mm
(**ΤΡΥΠΑ-ΤΡΥΠΑ**)/Hole - Hole: 33mm

00013780 
ΚΩΔ./Code 10,00 €

ΧΕΛΙΔΟΝΕΣ ΣΚΑΛΙΣΤΗΡΙΩΝ

Row crop sweeps



A: 260mm
ΠΑΧΟΣ/Thickness: 5mm
ΤΡΥΠΕΣ/Holes Ø: (2) 12x12mm
(**ΤΡΥΠΑ-ΤΡΥΠΑ**)/Hole - Hole: 36mm

00017817 
ΚΩΔ./Code 7,00 €



A: 300mm
ΠΑΧΟΣ/Thickness: 5mm
ΤΡΥΠΕΣ/Holes Ø: (2) 12x12mm
(**ΤΡΥΠΑ-ΤΡΥΠΑ**)/Hole - Hole: 36mm

00008266 
ΚΩΔ./Code 8,30 €



A: 350mm
ΠΑΧΟΣ/Thickness: 5mm
ΤΡΥΠΕΣ/Holes Ø: (2) 12x12mm
(**ΤΡΥΠΑ-ΤΡΥΠΑ**)/Hole - Hole: 36mm

00012782 
ΚΩΔ./Code 10,00 €

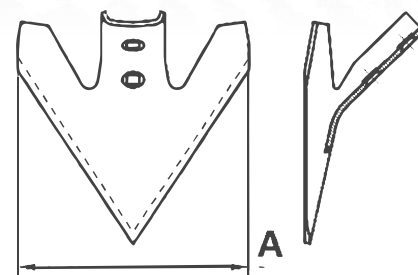

ΑΥΛΑΚΩΤΗΡΕΣ ΣΚΑΛΙΣΤΗΡΙΩΝ

Row crop ditchers



A: 335mm
ΠΑΧΟΣ/Thickness: 4mm
ΤΡΥΠΕΣ/Holes Ø: (2) 12x12/12x24mm
(**ΤΡΥΠΑ-ΤΡΥΠΑ**)/Hole - Hole: 42mm

00013358 
ΚΩΔ./Code 15,00 €

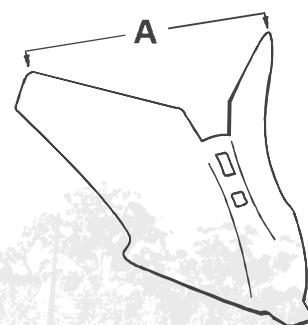

**ΠΤΕΡΥΓΙΑ
ΚΑΛΛΙΕΡΓΗΤΩΝ**
Cultivator wing shares

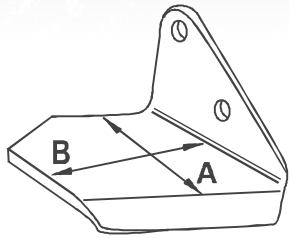

ΠΡΟΣΑΡΜΟΓΗ/Fitting: HORSCH
ΔΕΞΙΟ ΚΟΝΤΟ / Short (Right)
TIGER AS, TIGER LT, TIGER MT,
TERRANO FX, TERRANO FG
OEM: 34060855

A: 105mm B: 70mm
ΠΑΧΟΣ/Thickness: 10mm
(ΤΡΥΠΑ-ΤΡΥΠΑ)/Hole - Hole: 60mm

00017382 
ΚΩΔ./Code 8,00 €



ΠΡΟΣΑΡΜΟΓΗ/Fitting: HORSCH
ΑΡΙΣΤΕΡΟ ΚΟΝΤΟ / Short (Left)
TIGER AS, TIGER LT, TIGER MT,
TERRANO FX, TERRANO FG
OEM: 34060854

A: 105mm B: 70mm
ΠΑΧΟΣ/Thickness: 10mm
(ΤΡΥΠΑ-ΤΡΥΠΑ)/Hole - Hole: 60mm

00017382 
ΚΩΔ./Code 8,00 €



ΠΡΟΣΑΡΜΟΓΗ/Fitting: HORSCH
ΔΕΞΙΟ ΜΑΚΡΥ / Long (Right)
HORSCH TIGER AS, TIGER LT, TIGER MT,
TERRANO FX, TERRANO FG
OEM: 34060857

A: 100mm B: 185mm
ΠΑΧΟΣ/Thickness: 10mm
(ΤΡΥΠΑ-ΤΡΥΠΑ)/Hole - Hole: 60mm

00017635 
ΚΩΔ./Code 9,50 €



ΠΡΟΣΑΡΜΟΓΗ/Fitting: HORSCH
ΑΡΙΣΤΕΡΟ ΜΑΚΡΥ / Long (Left)
HORSCH TIGER AS, TIGER LT, TIGER MT,
TERRANO FX, TERRANO FG
OEM: 34060857

A: 100mm B: 185mm
ΠΑΧΟΣ/Thickness: 10mm
(ΤΡΥΠΑ-ΤΡΥΠΑ)/Hole - Hole: 60mm

00017635 
ΚΩΔ./Code 9,50 €

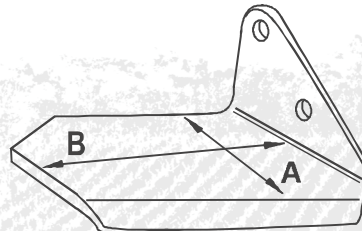

ΛΕΠΙΔΕΣ ΧΟΡΤΟΚΟΠΤΙΚΩΝ

Disc mower blades

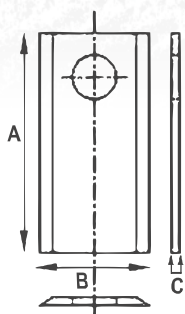

ΤΥΠΟΣ/Type: ΙΣΙΑ/Plain blade
ΠΡΟΣΑΡΜΟΓΗ/Fitting: TONUTTI, P/Z, GALFRE

A: 105mm B: 49mm C: 4mm
ΤΡΥΠΑ/Hole Ø: 21mm

00003592
ΚΩΔ./Code **0,96 €**



ΤΥΠΟΣ/Type: ΙΣΙΑ/Plain blade
ΠΡΟΣΑΡΜΟΓΗ/Fitting: FAHR

A: 94mm B: 40mm C: 4mm
ΤΡΥΠΑ/Hole Ø: 19mm

00011237
ΚΩΔ./Code **0,75 €**

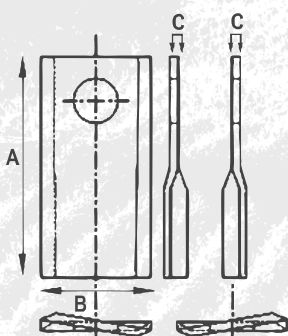

ΤΥΠΟΣ/Type: ΜΕ ΚΛΙΣΗ/Inclined blade
ΠΡΟΣΑΡΜΟΓΗ/Fitting: KUHN
ΑΡΙΣΤΕΡΗ (Left) - OEM: 559032

A: 107mm B: 45mm C: 4mm
ΤΡΥΠΑ/Hole Ø: 19mm

00003615
ΚΩΔ./Code **1,05 €**



ΤΥΠΟΣ/Type: ΜΕ ΚΛΙΣΗ/Inclined blade
ΠΡΟΣΑΡΜΟΓΗ/Fitting: VICON
ΑΡΙΣΤΕΡΗ (Left) - OEM: 58699

A: 120mm B: 49mm C: 4mm
ΤΡΥΠΑ/Hole Ø: 18,5mm

00014975
ΚΩΔ./Code **1,15 €**



ΤΥΠΟΣ/Type: ΜΕ ΚΛΙΣΗ/Inclined blade
ΠΡΟΣΑΡΜΟΓΗ/Fitting: KUHN
ΔΕΞΙΑ (Right) - OEM: 559033

A: 107mm B: 45mm C: 4mm
ΤΡΥΠΑ/Hole Ø: 19mm

00003616
ΚΩΔ./Code **1,05 €**



ΤΥΠΟΣ/Type: ΜΕ ΚΛΙΣΗ/Inclined blade
ΠΡΟΣΑΡΜΟΓΗ/Fitting: VICON
ΔΕΞΙΑ (Right) - OEM: 58700

A: 120mm B: 49mm C: 4mm
ΤΡΥΠΑ/Hole Ø: 18,5mm

00014976
ΚΩΔ./Code **1,15 €**

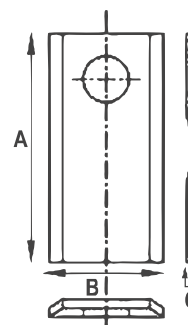

ΤΥΠΟΣ/Type: ΚΑΜΠΟΥΡΑ/Curved blade
ΠΡΟΣΑΡΜΟΓΗ/Fitting: PZ, MARAGON
OEM: 58700

A: 108mm B: 47mm C: 4mm
ΤΡΥΠΑ/Hole Ø: 21mm

00003676
ΚΩΔ./Code **0,96 €**



ΤΥΠΟΣ/Type: ΚΑΜΠΟΥΡΑ/Curved blade
ΠΡΟΣΑΡΜΟΓΗ/Fitting: PZ CM120, ROTTINGER, KRONE

A: 105mm B: 47mm C: 4mm
ΤΡΥΠΑ/Hole Ø: 21mm

00011253
ΚΩΔ./Code **0,96 €**



ΘΕΟΧΑΡΙΔΗΣ Α.Ε.Β.Ε.
ΓΕΩΡΓΙΚΑ ΜΗΧΑΝΗΜΑΤΑ & ΕΞΑΡΤΗΜΑΤΑ

ΑΝΩ ΠΥΡΙΤΣΑ, ΚΑΛΟΧΩΡΙ
Τ.Κ. 57009, ΘΕΣΣΑΛΟΝΙΚΗΣ
Τ. 2310.753210, 753290
Τ. 2310.754079, 754242,
F. 2310.754242
email: sales@theoharidis-sa.gr,
www.agroequip.eu



www.agroequip.eu